

1/3

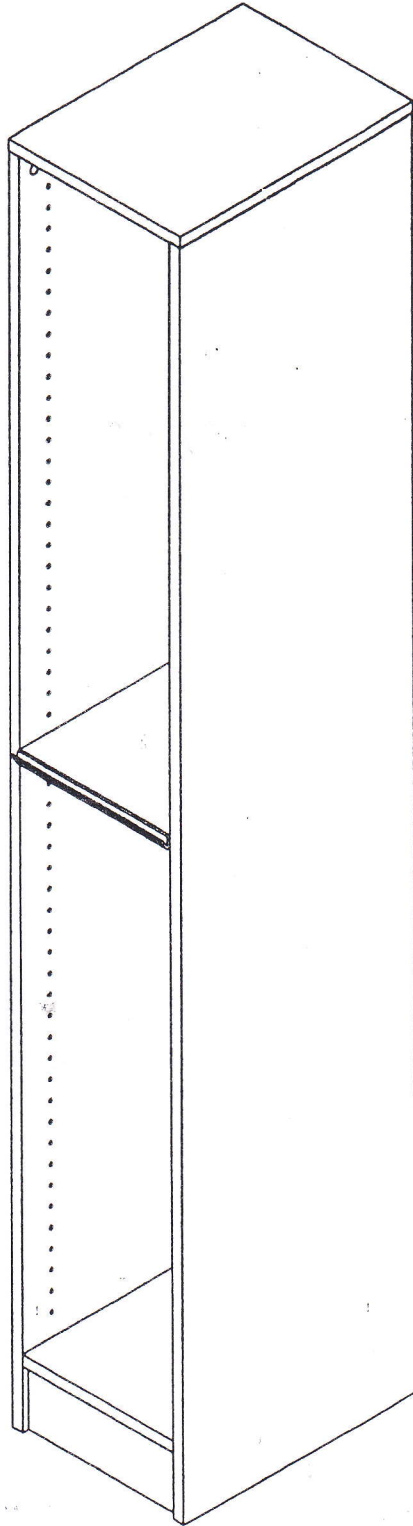

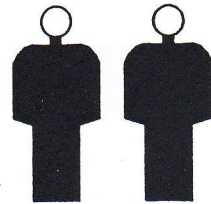

2/3

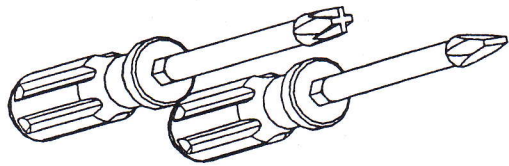
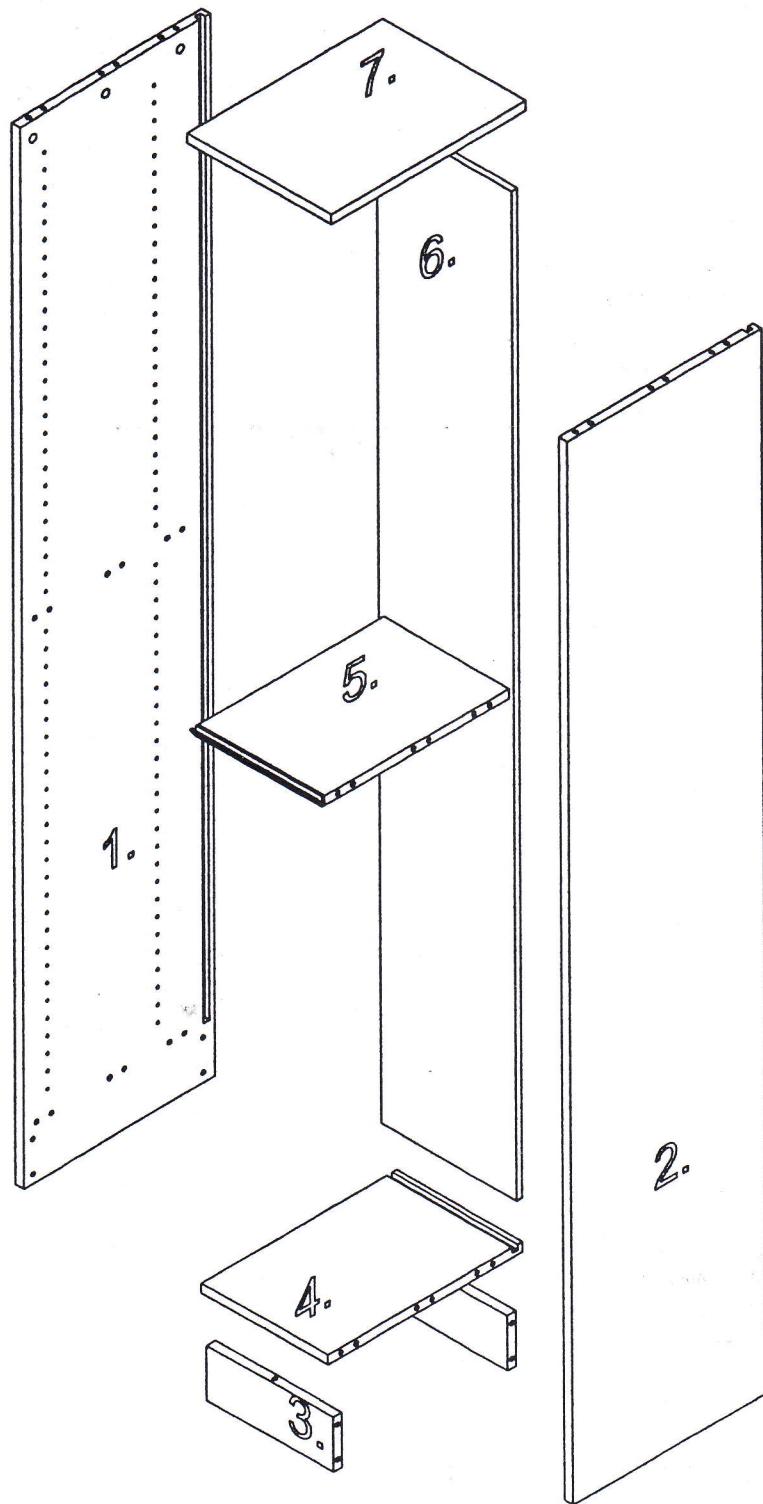

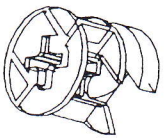

Ax18

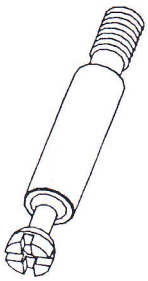

Bx18

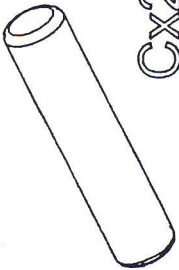

Cx28



Dx18

3/3

